



---

MX  
SERIES  
POWER  
AMPLIFIERS

---

MX 1500/MX 2000  
INSTALLERS  
MANUAL

---

**Table of Contents**

**Section One....Introduction**

- 1-1 Welcome
- Warranty
- Overview and Description

**Section Two....Basic Instructions**

- 2-1 Unpacking and Inspection
- Important Installation Precautions
- 2-3 Quick Instructions
  - Stereo Operation
  - AC Power
  - Floating Chassis Ground
  - Input Connection
  - Speaker Connections
- 2-4 Power up
  - Operation and Indicators

**Section Three....Operation**

- 3-1 Cooling
- 3-1 AC Requirements
  - AC Tolerances
- 3-2 AC Supply
- 3-2 Input Connections
  - Input Labeling
  - Input Jacks
  - Input Circuit
- 3-3 Balanced Inputs
  - Unbalanced Input and Polarity
- 3-5 Quasi-balanced lines
  - Cross Connecting Both Channels
- 3-6 Good Quality Connections
- 3-7 Bridged Mono
- 3-7 Speaker Connection
  - Terminal Polarity
  - Speaker Voltages
- 3-8 Speaker Cables
  - Cable Termination
  - Cable Polarity
  - Speaker Impedance
- 3-9 Speaker Wire Table
- 3-10 Distributed Sound Systems
  - Introduction
  - 25-Volt Lines
  - 3-11 70-Volt Lines
    - 100-Volt Lines
    - Auto-Bridge Backup (TM)
    - Low Frequency Rolloff

- 3-12 Amplifier Protection Features
  - Summary
  - 3-12 Short Circuit Protection
  - Thermal Protection
- 3-13 DC Fault Protection
  - Turn-on/turn-off Muting
  - Input/Output Protection
  - Indicators

#### **Section Four....Troubleshooting**

- 4-1 Summary
  - No Sound
  - Weak but Clear Sound
  - Weak and Distorted Sound
- 4-2 Sound Cuts In and Out
  - Sound has Bad Tone
  - Lacks Power
- 4-2 Unwanted Noise
  - Hum
- 4-3 Buzz
  - Hiss
  - Crackles

#### **Section Five....Speaker Protection**

- 5-1 Background
  - DC Protection
  - Horn Driver Protection
- 5-2 Horn Protection Capacitors
  - Power Capacity
- 5-3 Power Limiting
  - User Responsibility

#### **Section Six...Maintenance & Service**

- 6-1 Cleaning
  - Dust Removal
  - User Maintenance
  - Obtaining Service

#### **Section Seven...Specifications & Schematics**

- 7-1 Specifications
  - Front & Rear Panels
  - Schematics

Thank you for selecting a QSC MX 1500/2000 power amplifier for your audio system. Our goal is to be sure you remain happy with your amplifier for many years to come. Please do not hesitate to call your QSC Dealer or QSC Audio Products if you have any service problems or questions not answered in this manual.

**Welcome.**

Your QSC MX 1500/2000 power amplifier can be readily operated by anyone familiar with pro audio systems. Because there are certain characteristics which the industry has not yet standardized, we recommend that experienced as well as first-time users review the contents of this manual.

Please consult the Table of Contents for fast guidance to the sections of interest. We recommend that all users read Section 2 under Basic Instructions---Unpacking and Inspection, Important Precautions, and Quick Instructions.

QSC Audio Products warrants this product to be free from defective material and/or workmanship for a period of three years from date of sale, and will replace defective parts and repair malfunctioning products under this warranty when the defect occurs under normal installation and use; provided the unit is returned to our factory or one of our Authorized Service Stations via prepaid transportation. This warranty provides that examination of the returned product must disclose, in our judgment, a manufacturing defect. This warranty does not extend to any product which has been subject to misuse, neglect, accident, improper installation, or where the serial number has been removed or defaced. Manufacturer shall not be liable for consequential damages resulting from defects in materials and/or workmanship.

**Warranty.**

Each channel is completely isolated for minimum cross-talk and maximum reliability. Each has its own balanced bipolar power supply with high and low voltage DC levels. The balanced design assures proper dynamic response during peaks, and the high/low DC levels results in about twice the operating efficiency, or half the heat loss. The integrated circuit input stage and the complementary output transistors were selected both for reliability and outstanding audio performance. This combination delivers the required power with

**Overview of Amplifier.**

the minimum number of amplifying stages. This ensures minimum signal degradation with maximum reliability and consistency. The circuit accepts balanced or unbalanced input signals, and provides the high internal gain needed for low overall distortion and wide frequency response. Due to the circuit simplicity and the fact that we can use direct mounted output transistors, it is easier to maintain class AB operation (slight idle current to eliminate crossover distortion) over the entire temperature range of the amplifier. Another benefit is the ability to offer a high power amplifier of smaller size and lower weight than older designs.

Balanced or unbalanced inputs can be made with screw lugs to the barrier strip, or with 1/4-inch plugs (ring-tip-sleeve for balanced inputs). Speaker connections are made with 5-way binding posts.

The recessed front panel houses the AC switch, AC breakers, Gain controls, and essential read-outs. Power On/Protect and Clipping Indicators are provided for each channel, to monitor amplifier performance. The AC switch, circuit breakers, and gain controls are front mounted for convenience. The MX2000 also has a front panel mounted two speed fan switch and flashing red indicators for impending thermal overload on each channel.

The chassis is a welded, single piece design with integral rack mounting ears. The extra strength chassis and rugged mounting of internal parts contribute greatly to QSC's reputation for reliability by protecting the circuitry from years of road abuse.

To ensure that users get the full benefit of our high performance design despite real world hazards, our circuit includes many operational and protective features. Complete protection is provided for open circuit, short circuit, and mismatched loads; the amplifier will shut down temporarily if it overheats, and AC circuit breakers protect the power supply against unusual overloads. Our protection circuits are designed to ensure a minimum of false triggering and unwanted interruptions. Except for the AC breaker (which replaces the usual AC fuse), all protection systems will reset

automatically as soon as safe operation is assured. An equally important system protects the user's loudspeakers from unexpected damage, by muting the amp during turn-on and turn-off and by blocking DC faults (uncontrolled power breakdown) whether caused by the amplifier or preceding components.

All of these points are more fully explained in Section 2 and Section 3.

**Check for obvious carton damage while unpacking the unit, and check the amp for loose parts inside.** All QSC MX 1500/2000 amplifiers are double checked for good condition before being shipped from the factory. Despite the protective carton and rugged amplifier design, it is possible for shipping abuse to damage the amplifier.

**Unpacking and  
Inspection.**

**Please save the carton for return shipment, if required.** QSC does not warranty against damage caused by sending amplifiers back improperly packed or in the wrong carton.

**If shipping damage is evident, notify the transportation company immediately.** Only the consignee can file a claim with the carrier for shipping damage. QSC will cooperate fully in such an event. Be sure to save the carton for the shipper to inspect.

**The power must be OFF when making any connections.** If you connect plugs with the power on, especially in dry environments, static sparks or bad cables can cause pops or hums which can damage speakers.

**Important Installation  
Precautions.**

**When first powering up the amp,** have the amplifier Gain controls all the way off, in case of defective cables or hookups. Turn the Gain controls up gradually until normal operation is verified.

**Check the AC voltage printed on the serial number label to ensure your amp is properly configured for the AC voltage supplied in your area before connecting the AC plug.** CONNECTION TO A VOLTAGE SOURCE OTHER THAN THE ONE SPECIFIED WILL IMMEDIATELY DAMAGE THE AMP, and void the warranty.

**Never connect the speaker terminals (red binding posts) for two channels together on any power amplifier.** The two channels will fight each other and possibly fail.

**Do not connect the speaker ground terminals (black binding posts) to chassis or signal grounds,** as the resultant ground loop could cause ultrasonic oscilla-

tions. In other words, keep all speaker wiring separate for each channel, and separate from input wiring.

**Do not remove the amplifier cover, as there are dangerous voltages inside.** Do not expose to rain or moisture. Refer all servicing to qualified personnel. The warranty may be void if the amp is tampered with by non-QSC repair centers or personnel.

The QSC Warranty does not cover tampering by unqualified personnel, or repairs made at non-QSC repair centers. Please call the factory for Service Center information and locations.

High voltages can be present on the speaker terminals. Always connect speaker terminals with the power off, and use heavy gauge cable with no frayed strands or damaged insulation.

Please be aware that power amplifiers have high power circuitry inside with potential for fire and shock hazard; never plug in a damaged amplifier until the condition of the internal insulation is checked. If a circuit breaker blows quickly when turning the amp on, the channel is defective and should not be restarted until repaired or replaced. Failure to observe these precautions could lead to fire or shock hazard.

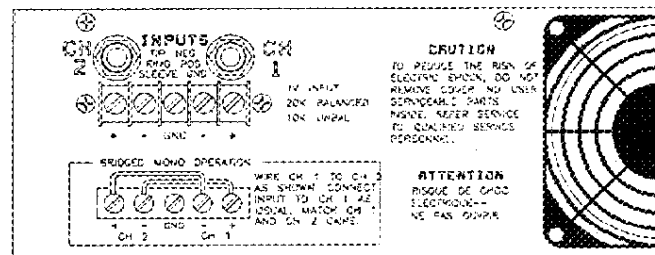

MX 1500

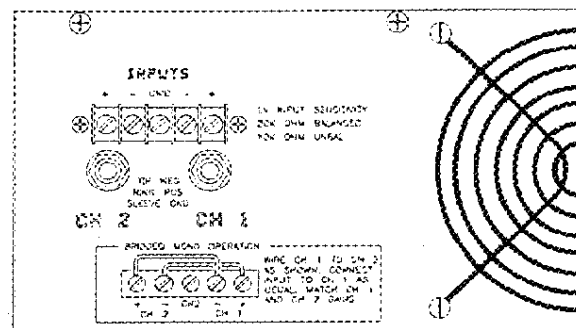

MX 2000



Always be aware that power amplifiers are inherently heavy and may become hot after use; provide adequate support and be careful how you grab the amplifier when handling it.

These instructions cover the normal use of the amplifier in two-channel or stereo applications. See Section 3 for detailed installation instructions and special cases.

Connect the AC cord to a standard outlet only. The amplifier will operate satisfactorily over a +/-5% range of voltages, but full rated performance will be met only at the rated voltage.

There is no provision for lifting signal ground relative to chassis ground on this model. Electronic balanced inputs are provided for hum rejection. Use balanced input cables to avoid hum and interference. For safety reasons do not remove the ground pin on the AC cord.

The input polarity is as follows:

1/4-inch plug: Tip is "minus" or inverting  
Ring is "plus" or non-inverting  
Barrel is ground, (as always).

Barrier Strip: "GND" is circuit ground  
"+" is the plus input  
"-" is the minus input

When making unbalanced connections, the unused terminal must be grounded for proper response. The barrel of an ordinary two-wire 1/4 inch plug will ground the "plus" side of the balanced input. The installer will need to ground the unused screw on the barrier strip.

You may connect banana plugs, spade lugs, or bare wire ends to the 5-way binding posts. Observe correct polarity (red/black terminals) so all speakers move in the same direction.

**Quick Instructions.**

**Stereo Operation.**

**AC Power.**

**Floating Chassis  
Ground.**

**Input Connection.**

**Speaker Connections.**

**Power Up.**

When first powering up, start with the gain controls off until proper operation is verified. Upon turning on the AC switch, the "Power" LED should come on, and after three seconds, the output relay should click in and sound can be heard. The amp should now be working, and the Gain control can be advanced. In case of difficulty consult Section 4.

**Operation and Indicators.**

Gain should be kept in the upper half of its range for full performance.

Monitor LED indicators are provided to monitor the operation of each channel. The bi-color green/red LED monitors indicates AC power (green) and actuation of the output relay (red). Each channel has a red "Clip" indicator that will show any distortion in the amplifier.

The relay should cut the sound off as soon as you turn off the amp, and mutes for three seconds before restoring power to the speakers. This blocks turn-on and turn-off thumps.

Please refer to Section 3 for more detailed instructions.

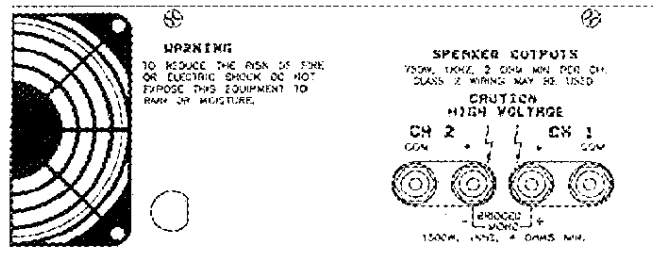

MX 1500

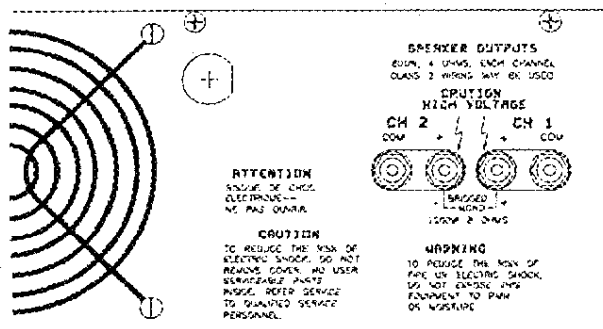

MX 2000

An internal fan forces air across heatsinks. Air flow is from the rear and warm air is exhausted to the front. This prevents the recirculation of heated air and reduces rack temperatures. Be sure that plenty of inlet space is allowed in the rack for free air flow. We did not provide dust filters, since small filters tend to clog quickly and reduce airflow. The design should confine dust to the "heat tunnel" formed by the heat sinks, but heavy build-ups should be removed from the inside of the amplifiers by using a compressed air jet through the fan intake several times a year. If used in a fixed installation, where removal is not convenient, consider an additional fan pack in the bottom of the rack with a large external dust filter. The additional fan will maintain air flow, and the external filter can be removed and cleaned from the front.

### **Cooling.**

The MX 2000 has a Fan Speed switch on the front panel. In normal operation the switch can be left in the Low speed position for quiet operation. For applications where the amplifier operates in a high ambient temperature at high power levels, into low impedance loads, the fan may be switched into the Hi speed position for maximum cooling. The High Temperature warning indicator on the front panel will flash if the amplifier is approaching shutdown due to overheating. Switching the fan speed to Hi will almost always allow the amp to continue operating uninterrupted.

When installing the MX 1500/2000 in the same rack with passively cooled amps or fan cooled amps that exhaust into the rack, locate the MX 1500/2000 amp on the bottom. This will assure the coolest air for all amps.

QSC amplifiers are designed for safe operation at AC voltages 10% higher than rated; however, temperature rise and transformer hum may increase somewhat. Operation on lower than normal AC voltages is not harmful to the amp, but performance will be progressively lost. For voltages down to 85% of nominal, no effect other than loss of peak power should be noticed. If voltage declines further, some increase in distortion, and possible power loss on peaks

### **AC Tolerances.**

may be noticed. The output relay may not come on at less than 70% of rated voltage, but once on, it should stay on down to about 30% of rated voltage. There should be no sub-audio or DC transients caused by fluctuating AC voltages. You should suspect poorly regulated preceding components if thumps or abnormally large voice-coil excursions are observed.

**AC Supply.**

In order to maintain full rated power, power amps as a rule require a definite and well regulated AC voltage. This is not always easy to assure when large banks of amps are used. The problem is further complicated by the fact that virtually all power amplifiers draw their power from the peaks or tips of the AC waveform. When many amps are used, or there is an excessive length of thin gauge AC wiring to the amps, these tips can be seriously diminished, causing the amps to lose power without a major effect on measured voltage.

Bulk power devices, such as lamps, on the same circuit may not be greatly affected, but other electronics components, which normally use the same type of power supplies, may be seriously affected during high-level audio peaks. This is especially true of sensitive devices like computers, video gear, etc. This is why power amps should have their own circuit if possible.

**Input Connections.**

(Please see illustrations in Section 2)

**Input Labeling.**

All input functions are located on the back of the amplifier, at the same end of the chassis.

**Input Jacks.**

1/4-inch ring-tip-sleeve and screw-terminal barrier strip inputs are provided for input connections.

**Input Circuit.**

An electronic balanced input is standard. This uses precision matched, 20K resistive dividers and the differential input terminals of a high performance 5532 op amp to accept balanced input signals and reject common mode noise signals. For best performance in the balanced input mode, the source should have equal impedances for both signal conductors, so that the loading effect on each leg will be the same for common mode (noise) signals. Minor mis-

matches will result in slight loss of common mode rejection, but will still have much greater noise rejection than unbalanced inputs. Another advantage of this circuit is that the input line is buffered from any distortion in the amplifier, so that amplifier overload does not "reflect" back into the signal line and contaminate the signal for some other function such as monitoring or tape recording.

For proper balanced line operation, the cable shield must be kept separate from both signal conductors. The cable shield is connected to the barrel of a 1/4-inch plug, or to the "GND" terminal of the barrier strip. Balanced-line cables contain two signal conductors, a "plus" polarity, often called "high" or "hot", and a "minus" polarity, called "low" or "return". Connect the "plus" conductor to the "ring" part of the 1/4-inch plug, or to the "plus" input of the barrier strip, for the amplifier to reproduce the signal in the same polarity (non-inverting operation). Connect the "minus" conductor to the tip of a 1/4-inch plug, or to the "minus" terminal of the barrier strip. See below for a greater discussion on the importance of overall polarity.

Since the input circuit responds to the difference between the plus and minus signals, if only an unbalanced (single-ended) signal is available, the unused input terminal need only be grounded for normal operation, without loss of gain. The ability to reject cable induced hum and noise is lost, but this may not be needed in well shielded environments with short distances between audio components.

Unbalanced operation raises an interesting question regarding the trade offs between maintaining standard system polarity and optimal stability. Normally, an amplifier is expected to reproduce input signals in the same polarity, which is called the non-inverting mode, so that a drum beat, say, pushes the speaker out instead of in. However, if there is any leakage from high power (speaker) circuits to the amplifier inputs, the amplifier is much more stable in the inverting mode, since the leakage then tends to add to the negative or stabilizing feedback. Using an inverting-mode power amp is the opposite of normal practice, but we have observed many cases where "mystery problems" occurring

### **Balanced Inputs.**

### **Unbalanced Inputs and Polarity.**

In wide band amplifiers used in the non-inverting mode are solved by switching to the inverting mode. Balanced line operation corrects this problem without regard to polarity, but is not always available. The next section suggests an easy way to make a "quasi-balanced" line for unbalanced components, but please read on to find the simplest "no hassle" connections for unbalanced equipment.

As a practical matter, we feel that in most situations, it is of very little importance to worry about overall amplifier polarity, as long as all the speakers are matched, because the polarity of mics, mixers, recordings, speakers etc. may be unknown. For this reason, we have used the safest or most stable assignment (inverting) for the input polarity of the 1/4-inch plug, to give average users with unbalanced equipment the most stable connection without getting bogged down in very subtle nuances of reproduction.

Unbalanced 1/4-inch plugs can simply be fully inserted in the 1/4-inch jack without special concern. The tip will contact the inverting terminal, and the barrel will automatically ground the sleeve or non-inverting terminal without any special wiring. As always, with unbalanced 1/4-inch connectors, the shield goes to the barrel.

You can wire to the "-" input of the barrier strip for stability, or the "+" input for theoretically correct polarity, and ground the unused input and the cable shield to the central "Gnd" terminal.

**NOTE.** You can always reverse the red-black polarity to all the speakers to restore correct polarity even when using the "more stable" inverting mode. In any case, be sure to use the same polarity for all of the speakers so they work together. If you can determine the polarity of the rest of the chain, you can always obtain positive overall reproduction polarity, by selecting the appropriate final polarity to the speakers.

Even if a balanced line output is not available, the benefits of balanced line input can still be obtained. Special cables will need to be made as follows:

**Quasi-balanced lines.**

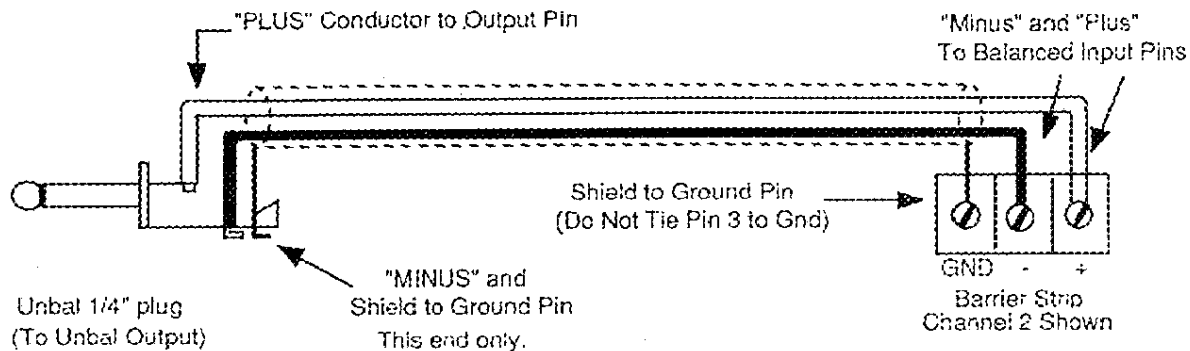

The end of the cable which connects to the power amplifier should be made as described in Section 3, using balanced line cable. At the other end, use a plug which matches the unbalanced output jack, and connect the "plus" conductor to its "hot" terminal. Connect the "minus" and shield conductors together to ground **AT THIS END ONLY**. Do not connect the "minus" and shield conductors together at the power amplifier (balanced input) end of the cable. This maintains the separation of signal ground and shield (circuit) ground needed to obtain balanced line noise rejection.

As a further refinement, a small variable resistance can be connected in series with the "minus" conductor, with a value roughly equal to the output impedance of the signal (usually less than 600 ohms). This resistance can be adjusted to null out any residual hum or interference.

You can always connect the inputs of two or more channels to the same signal, but **NEVER CONNECT TWO CHANNELS TO THE SAME SPEAKER**. Connect separate speakers to each channel to avoid amplifier damage.

**Cross Connecting Both Channels.**

Rather than using a "Y" cable for parallel inputs, jumper wires at the barrier strip can be used. This connects the input jacks for Ch.1 and Ch.2 in parallel making it easy to cross patch to as many channels as desired. Bring the input

signal into channel 1. Connect jumpers between the "+" terminals of Ch. 1 and Ch. 2, and also between the "-" terminals. (Do not be confused by the wiring diagram printed on the amplifier for Bridged Mono, Section 3). This will send the signal from Ch. 1 to Ch. 2. Then you may connect another cable from channel 2 of the first amp to channel 1 of the next amp. By using the same procedure in each amp, you can "loop through" to as many amps as desired. Each channel's Gain control will affect only that channel, not the signal reaching the other channels.

NOTE 1: For balanced line operation, you must maintain balanced cables all the way through. Any unbalanced cables will unbalance the whole network.

NOTE 2: It will not increase the power of a given amplifier channel by connecting additional channels. You must connect additional, separate speakers to each additional amp channel to multiply your total power rating. See Section 3 for a discussion of Mono Bridging, which is a partial exception to this rule.

Clean, tight connections are essential for good sound and to avoid erratic noises or unstable performance. 1/4-inch connectors are suitable for low cost portable systems, but must be removed and replaced frequently to avoid corrosion build-up. 1/4-inch plugs are not recommended for long, undisturbed service, especially in corrosive environments. For permanent wiring harnesses, the barrier strip is best, and also saves money. The cable wire itself can be stripped and carefully secured under the screw connectors, or spade terminals can be soldered or crimped onto the ends of the signal conductors. When crimping, be sure to use plenty of pressure, and closely inspect the resultant crimp while pulling the cable. If the wire wiggles inside the crimped terminal, the contact is not secure, and will go bad. If high pressure is maintained in the crimp and the screw terminal, a "gas-tight" connection is formed which will exclude corrosion for many years.



Most stereo amplifiers have a way of combining both channels in series to give their combined power into a single load. The rule is that the combined power of both channels will drive a single load of twice the impedance. Consult the table of specifications for power ratings (Section 7, Output Power, Bridged-Mono Operation).

To engage the bridged mono mode, jumper the barrier strip inputs on the rear, in accordance with the diagram printed under the barrier strip inputs. Connect the amplifier input to Ch.1 only, with the jumpers as shown to channel 2. Do not feed another input into Channel 2. Channel 1 and 2 Gains must be matched. A 4, 8 or 16 ohm speaker load can be connected across the two red speaker terminals, using the red binding post of Ch.1 for "+" or "hot".

**Mono Bridge Precautions:**

- a. Minimum load impedance is 4 ohms, which will be the equivalent, to the amp, of 2 ohms per channel. Be sure the speakers can handle the high power ratings (see Section 7, Bridged Mono Ratings).
- b. Both sides of the speaker cable are "hot" or active. Do not connect any other circuit to either speaker conductor.
- c. With a 4 ohm load, the amp will be working at its rated limit (2 ohms per channel).  
Assure adequate cooling and AC power.

Red and Black 5-way binding posts, on standard 3/4-inch centers, are located on the rear of the chassis.

The Red binding post carries the positive or "hot" speaker output. The Black binding post is the ground return for the speaker. Do not ground the speaker common to other parts of the chassis as this might cause audio ground loops and oscillations.

Because of the amplifier's high power capability there is a possibility of shock hazard at the speaker terminals. Always make connections with the power off, and observe good

**Bridged Mono .**

**Speaker Connection.**

**Speaker Terminals.**

**Terminal Polarity.**

**Speaker Voltages.**

wiring practice and avoid stray wire strands.

**Speaker Cables.**

In order to obtain the full benefit of the high power and high damping factor, the user must be careful to avoid cable losses. The best way is to use the heaviest gauge, finely stranded wiring possible. 12 gauge speaker cable is available, and heavier gauge "specialty" cable is sold by audio dealers.

**Cable Termination.**

A major problem with heavy gauge cables is that the ends are too large to fit most speaker terminals.

Usually, it is necessary to install spade lugs on each end, which must be soldered or soundly crimped. These must then be screwed firmly under the binding posts. Dual banana plugs are more convenient for portable systems, and will normally accept at least 12 gauge wires.

**Cable Polarity.**

Be sure to observe correct polarity at both the speaker and amplifier end. Most present day speaker cable is color-coded in some way, either by insulation color or by copper and tin-plated wires. Adopt a consistent wiring convention and stick to it. We suggest Black for "Com" (ground or negative) and Red for "Spkr" (hot or positive). These colors match the binding posts. By the same logic, we can assign the copper colored wire to the Red ("Spkr") terminal, and the silver colored wire to the Black ("Com") terminal.

**Speaker Impedance.**

The MX 1500/2000 amplifier has adequate current capability to fully drive loads down to two ohms. However, many high performance "8-ohm" loudspeakers, especially multi-way systems with passive crossovers, have impedances at some frequencies which are far lower than the average rating. An impedance minimum of 2 ohms or less is not uncommon. For this reason, speaker impedance curves should be consulted before connecting speakers in parallel. We would expect the amplifier to do an outstanding job with any 8 ohm, full range speaker system, and we expect equally outstanding performance when driving 4 ohm loads without passive crossovers (as part of a bi or tri-amped system, for instance). 2 ohm loads should be approached with caution, as

there is no further margin for impedance dips. 2 ohm operation will not damage the amp, but high power operation into reactive 2 ohm loads may result in overheating or excessive AC current consumption, causing shutdowns. In addition, some power may be lost at those frequencies where the impedance dips below 2 ohms. For these reasons, operation with 2 ohm loads should be tested thoroughly before putting into use (The MX 2000 has greater 2 ohm drive capability than the MX1500).

The following table is presented to assist in selection of appropriate speaker wire. Power losses and net damping factors (including the amplifier) are shown for a variety of lengths and gauges. Note that loss of power and damping factor are more severe for longer lengths, lower impedance loads, and higher (thinner) gauge wires. One should maintain a minimum damping factor of 20, and preferably 50 for high quality systems. This will automatically prevent significant power loss. Although a power loss of 10% is barely audible, the resultant low damping factor will prevent the amplifier from fully controlling the peaks and dips in frequency response caused by speaker impedance variations. This will result in more coloration and muddiness.

**Speaker Wire Table.**

Cable Length, Feet	Cable Gauge, each Conductor	Cable Resistance Ohms	Power Loss	Power Loss	Damping Factor	
			8 ohms	4 ohms	Allowing for Amp Damping of 200	8 ohms 4 ohms
5	18	.063	.79%	1.58%	77	38
	16	.040	.5	1.0	100	50
	14	.025	.31	.62	123	61
	12	.016	.20	.40	142	71
	10	.010	.125	.25	160	80
10	18	.126	1.58%	3.16%	48	24
	16	.080	1.0	2.0	66.6	33
	14	.050	.62	1.25	89	44
	12	.032	.40	.80	111	56
	10	.020	.25	.50	133	66
20	18	.252	3.16%	6.3%	27.4	13.7
	16	.160	2.0	4.0	40	20
	14	.100	1.25	2.5	57	28
	12	.064	.80	1.6	77	38
	10	.040	.5	1.0	100	50
40	18	.50	6.32%	12.6%	14.7	7.3
	16	.32	4.0	8.0	22.2	11.1
	14	.20	2.5	5.0	33.3	16.6

**Speaker Wire Table**  
**Continued.**

Cable Length, Feet	Cable Gauge, each Conductor	Cable Resistance Ohms	Power Loss	Power Loss	Damping Factor	
			8 ohms	4 ohms	Allowing for Amp Damping of 200	6 ohms 4 ohms
40	12	.128	1.60	3.2	47.6	23.8
	10	.080	1.0	2.0	67	33
	8	.050	.625	1.25	69	45
80	16	.64	8.0%	16.0%	11.8	5.9
	14	.40	5.0	10.0	18.2	9.1
	12	.256	3.2	6.4	27	13.5
	10	.160	2.0	4.0	40	20
	8	.10	1.25	2.5	57	29
160	14	.80	10.0%	20.0%	9.5	4.75
	12	.51	6.4	12.8	14.5	7.25
	10	.32	4.0	8.0	25	12.5
	8	.20	2.5	5.0	33.3	16.6
320	12	1.04	12.8%	25.6%	7.4	3.7
	10	.64	8.0	16.0	11.76	5.88
	8	.40	5.0	10.0	18.2	9.1

**Distributed Sound Systems.**

**Introduction.**

Commercial sound systems commonly use dozens or even hundreds of speakers for sound distribution. To avoid complex speaker hookups and impedance calculations, special "Constant Voltage" distribution systems are used by commercial sound contractors. Audio power is distributed at a defined voltage, such as 25, 70, or 100 volts (peak rms value before clipping). Speakers are connected across the line, using special step-down transformers which permit the desired power to be selected, such as 10W, 5W, 2.5W, etc. As more speakers are added, the line becomes more fully loaded, until the combined power of all speakers equals that of the amplifier. The system is similar to ordinary electric lighting, where all bulbs are 120V, but different wattages may be used, and bulbs turned on or off until the maximum circuit wattage is reached.

**25-Volt Lines.**

The MX 1500 amplifier delivers about 40-50V (45-55V MX2000) rms per channel (or about 70V peak), depending on loading. Either channel therefore has more than adequate voltage to drive 25V lines. However, 25V lines are usually specified as an economical alternative in

areas where safety codes require special wiring for voltages over 42V peak, which is defined by UL as potentially hazardous. Special circuitry or an output transformer to limit the MX 1500/2000 to 42V peak might be required in such cases; a smaller power amplifier such as the QSC 1200, with exactly 25V output at 150W per channel may be a better choice.

The MX 1500/2000 will drive 70 volt lines directly in the bridged mode (see Section 3), with up to 1500 watts (2000 watts MX2000) of power. Actual undistorted maximum voltages will range from 75V at 1500 watts loading to 100V at 700 watts loading (90V at 2000 watts to 110V at 750 watts for MX2000). If codes require peak voltage to be limited to 100V peak (70V rms), special circuitry may be required. The QSC OT-300 can also be used to step up the output of individual channels to 70V, at 300-400 watts.

#### **70-Volt Lines.**

The MX 1500/2000 will drive 100 volt lines directly in the bridged mode (see Section 3) with up to 700 watts of power (1200 watts for MX 2000). For higher loading, the amplifier will clip slightly below 100V, but at 1000 watts loading, the loss is less than 0.5 dB (2000 watt loading, loss less than 1 dB for MX 2000). The QSC OT-300 output autotransformer can also be used to step up individual channels to 100V, with up to about 300 watts available per transformer. Multiple transformers may be used in parallel adding up to the power rating of the channel.

#### **100-Volt Lines.**

When operating in the bridged mode, either channel can fail, and the signal will continue safely, at reduced level (-6dB) in the remaining channel. This can be invaluable in applications where "the show must go on".

#### **Auto-Bridge Backup (TM).**

In commercial sound systems, a rolloff below about 50Hz is desirable to prevent excess drive and wasted power at frequencies below the range of the speakers and their small transformers.

#### **Low Frequency Rolloff**

## **Amplifier Protection Features.**

### **Summary.**

We have ensured that accidents, mistakes, and abuse will have the minimum possible chance of harming the amplifier. The major challenge was to do this without impairing the audio performance into normal loads.

### **Short Circuit Protection.**

The active region in a power transistor is surprisingly small—perhaps 1/5 of an inch. This little piece of silicon must control up to hundreds of watts of power. If not managed properly this can burn out the silicon, instantly destroying the transistor. Under normal conditions, most of the power passes through the transistor, into the speaker, producing useful power and only some waste heat. If too many speakers (too low of an impedance) are connected, more power will be drawn through the transistor and more heat will be wasted. If the load impedance drops to zero, which might happen if the speaker wires are shorted together, then there would be almost no limit to the power drawn through the transistor. The waste heat will be so high that the transistor will burn out. This is why solid state amps need short circuit protection. The patented QSC "Output Averaging" short circuit protection continuously monitors the actual load impedance. As long as it is within rated limits (above 2 ohms), the amount of waste heat in the power transistors is acceptable, and full audio power is allowed to continue. If the output impedance is reduced below 2 ohms, a high level current limit protects the transistors from immediate destruction without unnecessarily limiting performance. If a strong signal persists for more than a fraction of a second into a true short, the current limit is smoothly cut back to a lower value which the transistors can handle indefinitely.

The result is full performance into rated loads, ability to handle normal program peaks into marginal loads, and good protection into short circuits. At no time will the circuit cause abnormal distortion spikes or loss of sound.

### **Thermal Protection.**

In case of blocked ventilation, extremely heavy loading, or prolonged short circuit operation, the temperature of the

power transistors can rise to excessive levels. If the heat sink temperature rises to about 90C, the relay will be triggered permitting the circuit to rest until temperatures fall to safe levels. The "PWR/PROT" LED will change from green to red, and no sound will come through. Reset should occur within a minute or two. If thermal problems occur, check for blocked ventilation, proximity to a heat source, short circuit, or improper load (too many speakers). On the MX 2000, setting the Fan Speed switch to Hi will solve most overheating problems.

The MX 1500/2000 has a direct coupled (DC) output, and uses a heavy duty Load Grounding (TM) speaker relay for load protection, similar to our Series Three amplifiers. This has the advantage of connecting the defective channel's load to ground for extra protection.

The MX 1500/2000 uses its speaker relay for muting as well. The relay is a heavy duty type with special alloy silver contacts for reliable distortion free operation on high power speaker signals. There will be a three second muting interval after turn on. After turn off, or loss of power for any reason, the relay will mute within a quarter of a second.

The amplifier inputs are isolated by 10K resistors, which are part of the balanced input circuit. This protects the inputs from burn out due to extremely high input signals or RF interference. The amplifier output is isolated from capacitive and inductive loads by a ultrasonic network which decouples the speaker terminals slightly at frequencies above about 50kHz.

Each channel has two LED indicators ( Three on the MX2000). A red-green power LED shows green for normal operation, and red when the relay is in muting. A red LED accurately shows signal clipping distortion for each channel. If distortion is heard without clip indication, check for extremely low input Gain or distortion in other parts of the system. The MX2000 has an additional red LED indicator for High Temperature. This indicator begins to flash slowly when the internal temperature approaches a high level. As the temperature increases the LED flashes more rapidly.

**DC Fault Protection.**

**Turn-on/turn-off Muting.**

**Input/Output Protection.**

**Indicators.**

Setting the Fan Speed switch to the Hi position will usually cool the amp sufficiently to avoid shutdown.



This Section contains troubleshooting hints which should help you locate a problem. By using a step-by-step evaluation, comparing the function of both channels, and using one channel to check the inputs and outputs of the other, a problem can usually be isolated. Please refer to Section 2 for an illustration of the rear panel connections and functions.

**Summary.**

Power LED does not come on: There is no AC power. Check AC plug. Depress AC reset on front of amplifier, or check position of AC switch. Test the wall outlet with another device to check for power.

**No Sound.**

Power LED comes on: Either the input or output is not connected, or the channel is faulty. If one channel is working, use it to test the inputs and speaker wires from the bad channel. If there is still no sound, trace those connections back to the preceding unit and speaker to isolate the fault. If the good channel works using the bad channel's cables, then the fault is somewhere in the bad channel. Check the input jacks, trying an alternate type jack if possible, and check the speaker binding posts for looseness. Is the volume control turned up?

Usually indicates lack of input signal or incorrect Gain adjustment at some point. Again, if the other channel is working, try swapping the connections to see if the problem is in the channel or elsewhere. If the sound is very thin or muffled, suspect that one driver in a multi-way speaker has failed.

**Weak but Clear Sound.**

If the amplifier clip light comes on during the distortion, there is a shorted speaker cable, the speaker is blown out, or the amplifier channel is defective. If the clip light does not show during the distortion, this shows that the distortion is happening outside the amplifier. You will have to check for misadjusted or defective units before the amplifier, or bad speakers on the affected channel. Also verify that amplifier Gain is in the normal range (half way up or higher) to prevent input device overload.

**Weak and Distorted Sound.**

**Sound Cuts in and Out.**

This is caused by a bad connection somewhere. See if shaking the amp or the input/output connectors causes the problem. An intermittent connection to one side of the balanced input can cause a 6dB fluctuation of input level. If the sound stops for a minute or two, and then resumes by itself, check the amp for overheating (thermal shutdown, with red "Protect LED").

**Sound has Bad Tone.**  
(poor treble or bass)

The amplifier itself is very unlikely to develop a frequency response problem without more serious effects. Therefore, lack of frequency range must be traced to the speakers or preceding units.

**Lacks Power.**

This is a common but indefinite complaint. Is there a lack of power in the sense that it is soft but clear (see "Weak but Clear Sound") or does it seem to distort too easily (see "Weak and Distorted Sound"). Also, be aware that speaker efficiency will drop perceptibly after heavy usage, due to the increased resistance of the voice coils as they heat up. Volume will return when the speakers cool down. In a multi-speaker system, be sure all of the speakers are still working. Finally, of course, your ears get used to high sound levels, and as the room fills up with people, the sound will be absorbed more greatly. Only a sound level meter, used with a standard signal level and at a standard distance from the speaker, can really tell if you are getting the expected output.

**Unwanted Noises.**

**Hum.**

In this case, defined as a fairly rounded 60 cycle tone. Severe hum usually is caused by broken cables or jacks with disconnected ground (shield). This problem can also be caused by corroded connectors, especially 1/4-inch types. For this reason, high reliability systems should use barrier strip inputs. A milder form of hum, often with a little more "tone" or harmonic content, is usually the result of ground loops. This problem is caused by 60 cycle magnetic fields, which radiate from power transformers including the ones in the amplifier. Try repositioning the cables away from the various components. Note that tape recorder heads, phono

cartridges, and electric guitar pick-ups are especially sensitive to this type of interference, and must be kept away from high power electronics.

Defined as a very "razzy" kind of hum. This is usually caused by interference from solid-state light dimmer circuits. Follow the same precautions shown above, and make sure the electronics are not connected to an AC outlet which has a dimmer control.

**Buzz.**

Defined as a smooth "shhh" noise. This is always a problem with sensitive electronic inputs, and usually starts at the point of weakest signal. In a properly designed system, this will be the initial microphone, phono, or tape source. There is a noise "floor" caused by random atomic vibrations. This limits the signal to noise ratio of the original signal. The goal of a proper system is to have a quiet pre-amp which immediately amplifies the input signal to a standard "line level", well above the noise floor, so that further degradation does not occur.

**Hiss.**

"Gain-staging" is a subject in itself, but the idea is to maintain a fairly constant signal level after the initial pre-amp. To isolate the source of unwanted hiss, start at the amp and work backwards, reducing and then restoring gains. You should hear a reduction of hiss and audio together at each point, showing that the hiss is coming in earlier. When you find a control which lowers the audio volume, but not the hiss level, you know the hiss is coming in after that stage. Assuming that the hiss has not always been there, this indicates defective electronics. Certain special effects units are rather noisy so compare with other users.

Defined as a "popcorn" noise. If the crackle persists during pauses, this indicates defective electronics, and must be traced down using the above procedure. Crackles which occur during audio peaks or when the electronics are vibrated usually indicate bad connections.

**Crackles.**

Speakers have several limits which should not be exceeded for reliable operation. It is the user's responsibility to determine these limits and operate the amplifier accordingly. We offer several ways to avoid unexpected accidents, but you must still select speakers of appropriate type and power capacity.

All QSC amplifiers protect the speakers against amplifier faults, so no special protection is required for full range loudspeakers. The MX 1500/MX 2000 amplifier limits the response below 20Hz to protect the amp and load from possible damage caused by large subsonic transients, such as breath pops, dropped microphones, etc.

The compression drivers used with horns for high frequency reproduction have special low frequency protection requirements. These devices are more delicate than large cone speakers and more vulnerable to overload damage. In particular, the driver has a low-frequency limit which must be carefully observed. Below this frequency, the driver diaphragm can "bottom out" which will immediately alter the frequency response and quickly cause failure. To prevent this, the user must make sure that a proper crossover network is installed. In bi-and-tri-amp systems, where the driver is connected directly to the amplifier, the user must be especially certain that the correct frequency is used on the electronic crossover, and that no low frequency signals, such as loud hums, get into the signal path between the electronic crossover and the power amplifier. As further protection, especially against accidental misadjustment or bad cables, many users install "horn protection capacitors" between the amp and horn driver. This component inherently blocks lower frequencies and DC, but must be selected so as not to disturb the crossover frequency. A reasonable rule of thumb is to let the capacitor roll off one octave below the intended crossover frequency. A table of values is presented below. Be sure to use film type or non-polarized electrolytic capacitors, of at least 100V rating.

#### Background.

#### DC Protection.

#### Horn Driver Protection.

**Horn Protection Capacitors.**  
(Values in microfarads)

Frequency	8-ohm Driver	16-ohm Driver
500	80uf	40uf
800	50	25
1000	40	20
1200	33	16
2000	20	10
3500	12	6
7000	6	3

You will have some problems finding the larger value capacitors in the preferred film type construction. If necessary, several can be paralleled as shown below. Simply add the individual capacitances together to get the total rating. You will probably have to locate so called "non-polar" electrolytic capacitors for values greater than 10-20uF.

The selected value of capacitance should be connected in series with the horn as shown in the following drawing:

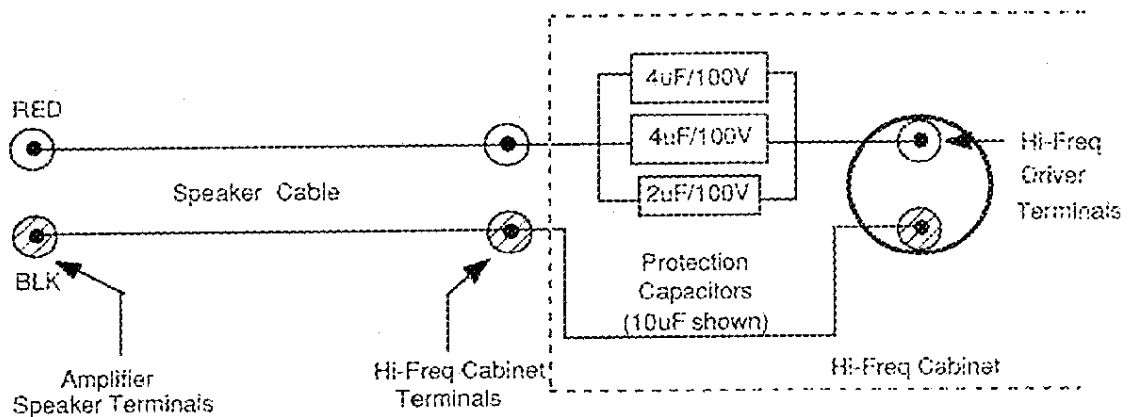

**Power Capacity.**

All speakers have a maximum long-term power limit which is determined by the temperature rise of the voice coil. The speaker can withstand short peaks above this level since the voice coil takes a little while to overheat. The time lag depends on the size and mass of the voice coil and ranges from a fraction of a second to several seconds. The required speaker rating for a given amplifier power depends on the type of program material. Extreme cases such as

lead guitar work may require speaker ratings of twice the RMS power of the amplifier to continuously withstand the full peak power. The average power of signals where some attempt is made to prevent overdrive distortion will be less than the amplifier RMS rating. How much less depends on the dynamic range and headroom allowance. In live-performance situations where feedback and high energy artists can push the system to its limits, it would probably be wise to match the RMS ratings of the speakers and the amplifiers.

There are several ways to limit the power to safe levels without operator intervention. Some speaker systems have protective circuits or fuses. Fuses can be added which will blow in case of overloads. The problem is to select a fuse with the correct time lag and overload characteristics to match the speaker limitations. The speaker manufacturer is in the best position to specify these values. The following table is presented for rough guidance only. The fuse values shown are calculated for fast blow fuses, which will carry 135% of their rating for an hour, and blow within 1 second at 200% current. The RMS power rating is matched to 135% of the fuse current.

**Power Limiting.**

RMS Power	4-ohms	8-ohms	16-ohms
30	2 amps	1.5 amps	1 amp
50	2.5	1.6 or 2	1.25
75	3	2 or 2.5	1.5
100	4	2.5	1.6 or 2
200	5	3 or 4	2.5
400	7.5	5	3 or 4

The fuse voltage is not critical. 32 volt fuses should have the lowest resistance which will avoid loss of damping factor.

The power may also be limited with active circuitry. Out-board compressors or limiters can be used for this function.

Remember that your MX 1500/2000 amplifier is very powerful with extra peak power (dynamic headroom) in reserve.

**User Responsibility.**

Observe the hook up and operating precautions. QSC is not liable for any damage to loudspeakers caused by overpowering, wrong frequency operation or electronic faults.

The faceplate and chassis can be cleaned with a soft cloth and mild non-abrasive cleaning solution, such as Windex. Avoid cleaning powders or scrubbing pads, as these will scratch and dull the paint. Be sure to unplug the unit prior to cleaning. Dampen the cloth with the cleaning solution and wipe gently. You may wish to buff the surface lightly with a dry soft cloth.

**Cleaning.**

After prolonged use, especially in dusty environments, the heat sinks may become clogged with dust. This will interfere with cooling, leading to higher temperature operation and reduced life. Some dust can be removed by directing an air jet in the fan intake on the rear. Severe build-ups will require qualified service personnel to remove the top cover for thorough dust removal.

**Dust Removal.**

There are no periodic "tune-up" adjustments required. The amplifier should provide stable performance until parts fail from age. Internal servicing must be referred to qualified personnel. The amplifier may be inspected for loose screws on the outside. If any loose parts rattle around on the inside, please have it serviced immediately, as a loose part could lodge in a dangerous place and cause further damage or shock hazard.

**User Maintenance.**

If the amplifier isn't working properly, please consult the troubleshooting chart in Section 4. If proper operation cannot be restored the amplifier may require service. This must be performed by qualified technical personnel, to avoid shock hazard or improper repairs. To obtain the location of the nearest authorized Service Center, please contact your QSC dealer or the QSC factory (714-645-2540, Costa Mesa, California).

**Obtaining Service.**

Please note that the warranty does not cover repairs made by non-authorized service personnel, and that improper repairs may void future warranty coverage.

If the amplifier is returned to the factory for service, it must be sent in a proper QSC shipping carton. If you have not saved your carton, ask your dealer for one, or call QSC to have an empty carton sent for shipping. The warranty does



not cover shipping damage caused by returning an amplifier in the wrong carton or improperly packed.

Specifications.		MX1500	MX2000
<b>Output Power</b> (per channel, RMS watts, both channels driven)	2 ohms, 1KHz, 1% THD +/- 1 dB	750	1000
	4 ohms, 1KHz, 1% THD	570	725
	4 ohms, 20-20KHz, 0.1% THD	500	600
	8 ohms, 1KHz, 1% THD	360	425
	8 ohms, 20-20KHz, 0.1% THD	330	375
<b>Bridged-Mono Operation.</b>	4 ohms, 1KHz, 1% THD +/- 1dB	1500	2000
	8 ohms, 20-20KHz, 0.1% THD	1000	1200
	16 ohms, 20-20KHz, 0.1% THD	660	750
<b>Dynamic Headroom.</b>	4 ohms	3dB	2dB
<b>Distortion.</b>	8 ohms, THD, 20-20KHz	Less than 0.1%, 0.01% typical	
	8 ohms, SMPTE-IMD	Less than 0.025% at rated power	
<b>Frequency Response.</b>	20-20KHz +/- 0.1 dB		
<b>Damping Factor.</b>	8-ohms, 50Hz greater than:	200	300
<b>Noise.</b>	20-20KHz	More than 100dB below rated power	
<b>Input Sensitivity.</b>	Vrms, 8 ohms	1.02	1.07
<b>Input Impedance.</b>	10K unbalanced (inverting polarity) 20K balanced		
<b>Controls.</b>	Front: AC Switch, Circuit Breakers, Gain Knobs, Fan Speed, MX 2000 only		
<b>Indicators.</b>	Front: Power/Protect: Green/Red LED		
	Clip: Red LED		
	High Temperature:	Flashing Red LED MX 2000 only	
<b>Connectors.</b>	Rear Inputs:	1/4-inch RTS, Barrier Strip	
	Speakers:	5-way Binding Post	

<b>Cooling.</b>	Fan:	rear intake, front exhaust	
<b>Amplifier Protection.</b>	Full Short Circuit*, open circuit, over-temp, ultrasonic and RF protection. Stable into reactive or mismatched loads. *U.S. Patent 4,321,554		
<b>Load Protection.</b>	Speaker Relay 3-Second Turn-On, Instant-Off Mute		
<b>Complementary Output Devices.</b>		24	40
<b>Amplifier Power Supply.</b>	Separate transformers, rectifiers, and DC filter capacitors for each channel.		
<b>Power Requirements.</b>	Watts	1/3 power (normal operation)	
	2 ohms	1350	1950
	4 ohms	1300	1450
	8 ohms	900	1000
<b>Dimensions.</b>	Width;	19-inch rack mounting	
	Height	3.5"	5.25"
	Depth;	incl. rear connectors 17.9"	
<b>Weight.</b>	Shipping, Lbs.	52	76
	Net, Lbs.	47	70

# OSC STEREO AMPLIFIER MODEL MX 1500

## NOTES

1. ALL CAPACITORS IN OMB, 1/4-WATT, 5% UNLESS SHOWN.
2. ALL CAPACITORS IN Ω OF 100Ω UNLESS SHOWN.
3. HEAVY LINE SHOWS MAIN SIGNAL PATH.
4. USE OSC REPLACEMENT RESISTORS ONLY.
5. 5% FLAMPROOF RESISTORS.
6. 5% NON-POLAR ELECTROLYTIC CAPACITORS.
7. 01-54, 8000Ω RESISTORS.
8. 213-217 ZENER DIODES.
9. 112, 100Ω FRONT PANEL LEDS.
10. AUDIO GROUND MARKED "A" CIRCUIT GROUND MARKED "C".

8 PIN INPUT JACK

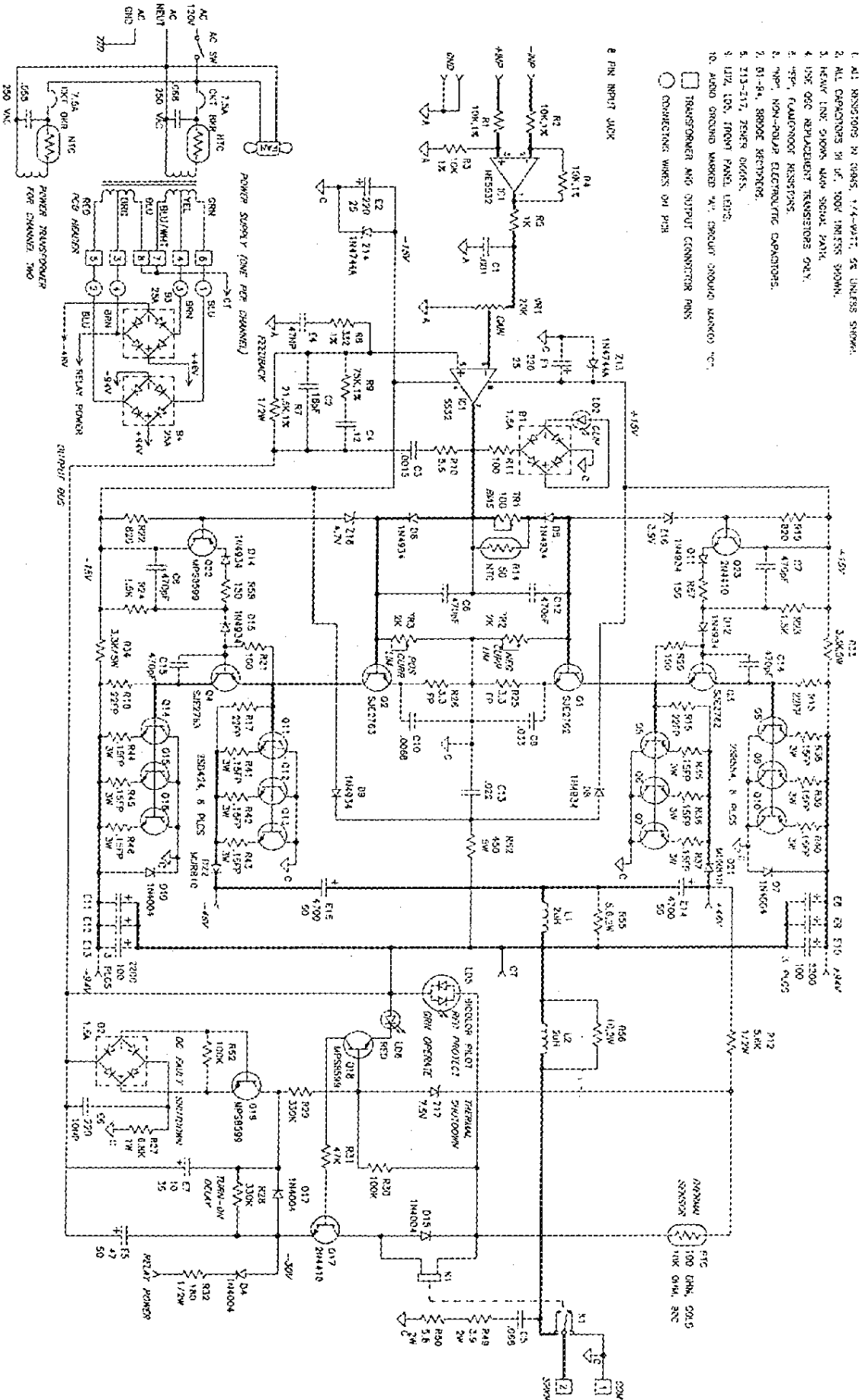

NOTES

1. ALL DIMENSIONS IN DWGS. VIZ. HOLE, DR. UNLESS SHOWN.
2. ALL CONNECTIONS IN DWG. 100% UNLESS SHOWN.
3. KEYS ARE SHOWN WITH SHOWN DATA.
4. ALL LOC. OR. UNLESS SHOWN.
5. ALL DIMENSIONS UNLESS SHOWN.
6. ALL DIMENSIONS UNLESS SHOWN.
7. ALL DIMENSIONS UNLESS SHOWN.
8. ALL DIMENSIONS UNLESS SHOWN.
9. ALL DIMENSIONS UNLESS SHOWN.
10. ALL DIMENSIONS UNLESS SHOWN.
11. ALL DIMENSIONS UNLESS SHOWN.
12. ALL DIMENSIONS UNLESS SHOWN.
13. ALL DIMENSIONS UNLESS SHOWN.
14. ALL DIMENSIONS UNLESS SHOWN.
15. ALL DIMENSIONS UNLESS SHOWN.

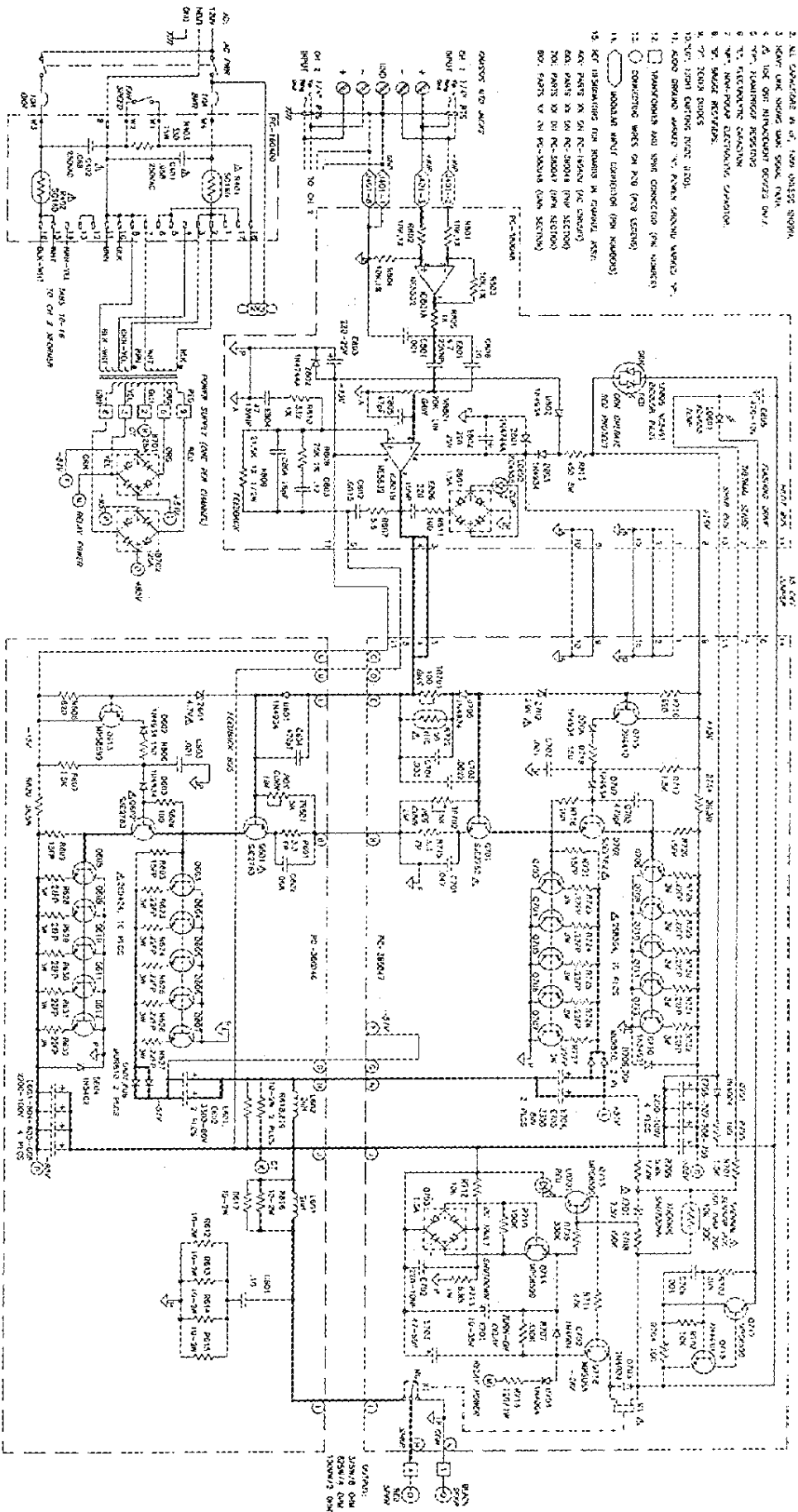



PC-30016	PC-30017	PC-30018	PC-30019
100K	100K	100K	100K
100K	100K	100K	100K
100K	100K	100K	100K
100K	100K	100K	100K



PC-30016	PC-30017	PC-30018	PC-30019
100K	100K	100K	100K
100K	100K	100K	100K
100K	100K	100K	100K
100K	100K	100K	100K

PC-30016	PC-30017	PC-30018	PC-30019
100K	100K	100K	100K
100K	100K	100K	100K
100K	100K	100K	100K
100K	100K	100K	100K

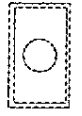
PC-30016	PC-30017	PC-30018	PC-30019
100K	100K	100K	100K
100K	100K	100K	100K
100K	100K	100K	100K
100K	100K	100K	100K

**QSC**  
MX 1500  
Dual Monaural Amplifier

PROT  CLIP  GAIN 1  RESET 1  ON  OFF

PWR  RESET 2  CLIP  PROT

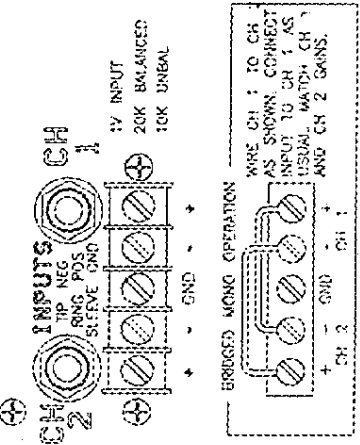

**CAUTION**  
TO REDUCE THE RISK OF ELECTRIC SHOCK, DO NOT REMOVE COVER. NO USER SERVICEABLE PARTS INSIDE. REFER SERVICE TO QUALIFIED SERVICE PERSONNEL.

**ATTENTION**  
RISQUE DE CHOC ELECTRIQUE--- NE PAS OUVRI

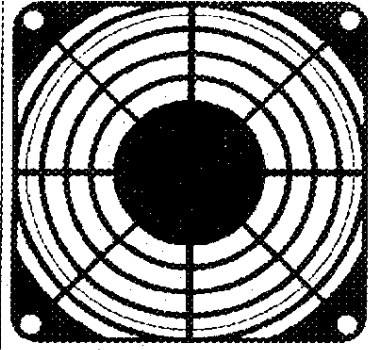

**WARNING**  
TO REDUCE THE RISK OF FIRE OR ELECTRIC SHOCK, DO NOT EXPOSE THIS EQUIPMENT TO RAIN OR MOISTURE.

**SPEAKER OUTPUTS**  
750W, 1KHZ, 2 GRM AMP PER CH.  
CLASS 2 WIRING MAY BE USED

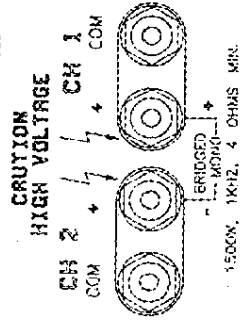

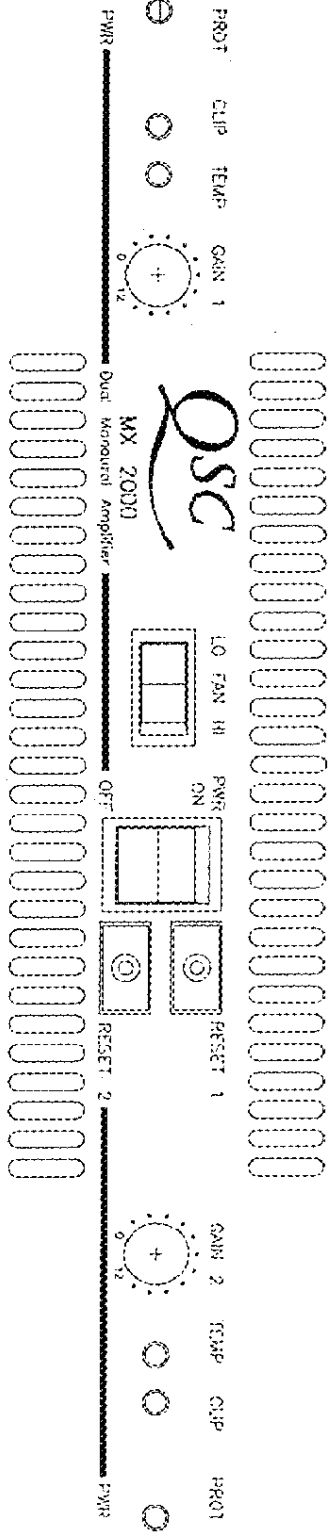

**INPUTS**

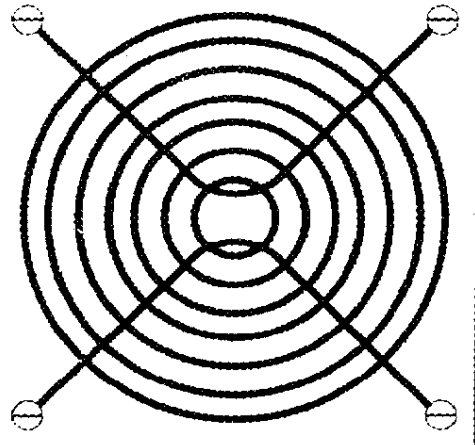
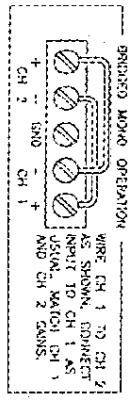
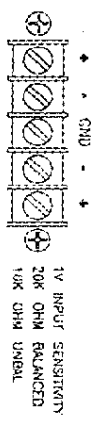

**SPEAKER OUTPUTS**

600W & OHMS, EACH CHANNEL  
CLASS 2 WIRING MAY BE USED.

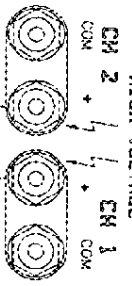

**CAUTION**  
TO REDUCE THE RISK OF ELECTRIC SHOCK, DO NOT REMOVE COVER. NO USER SERVICEABLE PARTS INSIDE. REFER SERVICE TO QUALIFIED SERVICE PERSONNEL.

**WARNING**  
TO REDUCE THE RISK OF FIRE OR ELECTRIC SHOCK, DO NOT EXPOSE THIS EQUIPMENT TO RAIN OR MOISTURE.